



FOOD PROCESSOR / VEGETABLE SLICER

WITH SCREEN



VEGETABLE SLICER	
Description	4
Technical features	5
FOOD PROCESSOR	
Description	6
Technical features	7
WARNING	8
USE OF THE VEGETABLE SLICER	9 - 17
USE OF THE FOOD PROCESSOR	18 - 36
CLEANING	36
MAINTENANCE	36
ELECTRIC REQUIREMENTS	37
ELECTRICAL DIAGRAM	37
CERTIFICATE OF CONFORMITY CUSTOMER SERVICE AND WARRANTY	37
SCHEMATIC AND PART LIST	38 - 45
WARRANTY	48

VEGETABLE SLICER DESCRIPTION



- A** Pusher
- B** Pusher Handle
- C** Lid
- D** Accessory (slicing disc, grating disc, julienne disc, etc.).
- E** Ejector
- F** Receptacle
- G** Locking system
- H** Motor-block
- I** Control panel

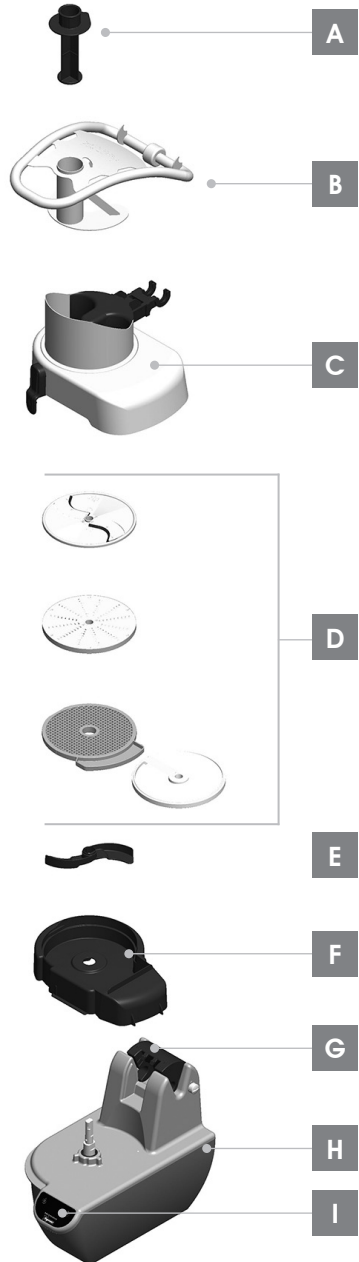

VEGETABLE SLICER TECHNICAL FEATURES

TENSION	220/240 V - 1Ph - 50-60Hz
POWER	1100W
SPEED	
• One speed :	320 RPM
• Two speeds :	320 and 640 RPM
• Variable speed :	320 to 720 RPM
DIMENSIONS	
<p>The technical drawings show the following dimensions:</p> <ul style="list-style-type: none"> Front View: Total height 510mm / 20", main body height 475mm / 18.7", width 400mm / 16", and a small protrusion height of 215mm - 8.5". Side View: Total height 510mm / 20", main body height 475mm / 18.7", and width 505mm / 20". Side Profile View: Total height 765mm / 30" and width 635mm / 25". 	
• Disc diameter	225mm
WEIGHT	
• Appliance (without disc)	27kg
• Motor-block	21kg
• Pusher handle	2.8kg
• Lid	2.5kg
• Receptacle	0.6kg
• Slicing disc	0.6kg
• Grating disc	0.4kg
• Julienne disc	0.7kg
• French fries kit (disc and grid)	1.4kg
• Dicing kit (disc and grid)	1.4kg
NOISE LEVEL	60 dB

FOOD PROCESSOR DESCRIPTION



- A** Lid
- B** Scraper
- C** Knife
- D** Stainless steel bowl
- E** Locking system
- F** Motor-block
- G** Control panel

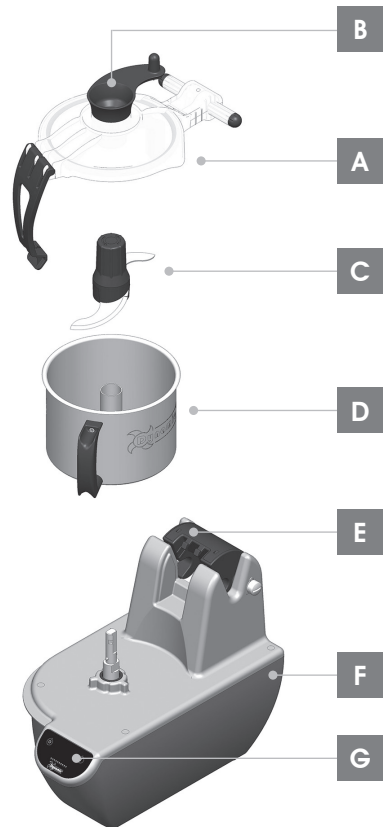

FOOD PROCESSOR TECHNICAL FEATURES

TENSION	220/240 V - 1Ph - 50-60Hz
POWER	1100W
SPEED	
• One speed :	1500 RPM
• Two speeds :	1500 and 3000 RPM
• Variable speed :	350 to 3500 RPM
• REVERSE :	80 to 350 RPM
• PULSE :	Available according to the model
DIMENSIONS	
WEIGHT	
• Appliance (without bowl and cover) :	27kg
• Motor-block :	21kg
• Stainless steel bowl (with cover) :	2.8kg
• Knife :	0.260 kg
STAINLESS STEEL BOWL VOLUME	
• Rated capacity :	5.4 litres
• Operating capacity :	4.3 litres
NOISE LEVEL	60 dB

WARNING

Read the entire manual before using the appliance for the first time.

Unplug the appliance before cleaning.

The motor block should not be cleaned with water jet or a steam cleaner.

This appliance may be used by children at least 8 years old and by persons with reduced physical, sensory or mental capacities or without experience or knowledge if they are correctly supervised or if they have been given instructions on how to use the appliance safely, and if they correctly understand the risks involved.

Children must not play with the appliance. Cleaning and care by the user must not be performed by unsupervised children.



The discs and grids have sharp edges. Be careful when handling or cleaning them, there is a risk of cuts. Warning, this appliance includes a moving blade. Take care when using it and when cleaning it as there is a risk of cuts.

These appliances are intended to be used for commercial applications, for example in kitchens of restaurants, canteens, hospitals and in commercial enterprises such as bakeries, butcheries, etc., but not for continuous mass production of food.

USE OF THE VEGETABLE SLICER

This machine allows to slice, grate, shred and dice food or cut sticks.

USE OF THE FOOD PROCESSOR

This appliance allows to grind, mix, chop more or less finely, mix and emulsify vegetables, meat or preparations.

It can also be used to make shortcrust pastry, bread dough, etc.

Whether it is in cutter or vegetable cutter mode, this appliance is only used for food preparations.

TRANSPORT AND HANDLING OF THE APPLIANCE



Considering the appliance weight, and in order to avoid any risk of injury, provide all necessary and suitable means to facilitate the handling and transport of the appliance.

The appliance must be placed on a flat, stable, rigid surface that is strong enough to support its weight and the vibrations that may be caused by its use.

Make sure that the location reserved for the appliance is large enough to allow the best use of the unit.

OPERATION OF THE VEGETABLE SLICER

Fitting of accessories

1. Fit the receptacle ① on the motor block ②.

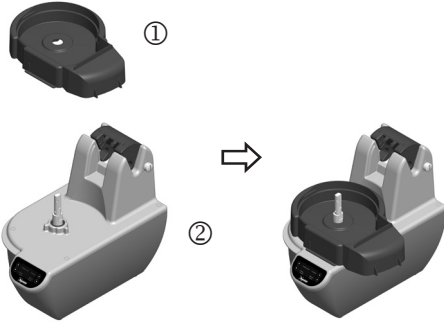

2. Fit the ejector ③.

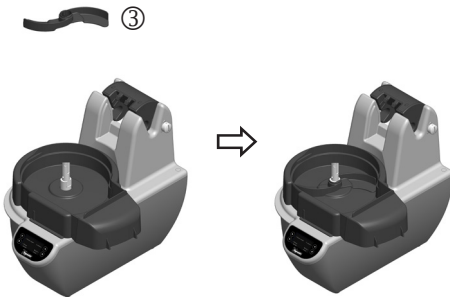

3. Choose the accessory (slicing disc, grating disc, etc.) the most suitable for the desired result and check its general condition (warping, oxidation, blade sharpness, etc.)



The discs and grids have sharp edges. Be careful when handling, there is a risk of cuts.

4. Fit the accessory ④ on the appliance.

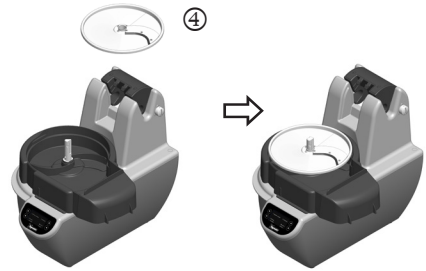

For slicing and julienne discs, first slide them along the motor output shaft and then turn them in the opposite direction of the arrow on the disc until they reach the stop.

For grating discs, simply slide the discs along the motor output shaft up to the stop.

For French fries and dicing kits and mixed vegetable kits, first fit the grid ⑤ and then the slicing disc ⑥.

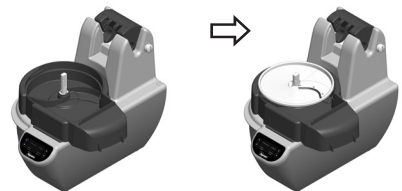
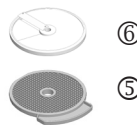

The discs and grids have sharp edges. Be careful when handling, there is a risk of cuts.

OPERATION OF THE VEGETABLE SLICER

5. Pull the lock latch and tilt the lock backwards.

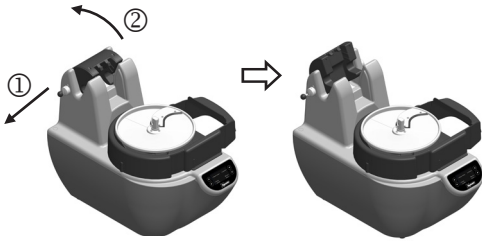

8. Tilt the lock.

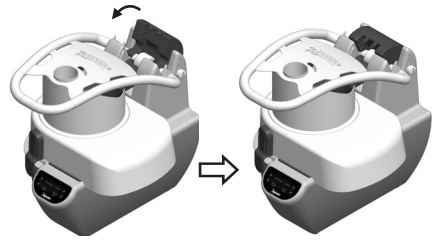

6. Fit the lid (7).

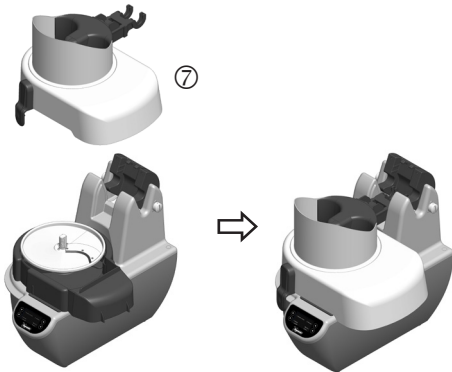

7. Fit the pusher handle (8).

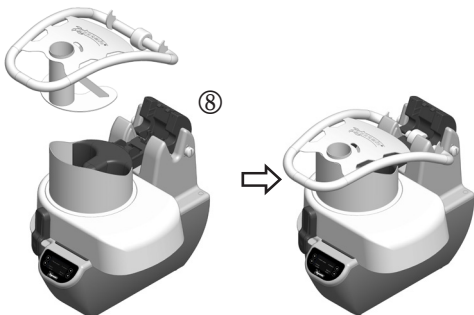

Removing the accessories

REMOVING THE PUSHER HANDLE AND THE LID

1. Pull the lock latch (1) and tilt the lock backwards (2).

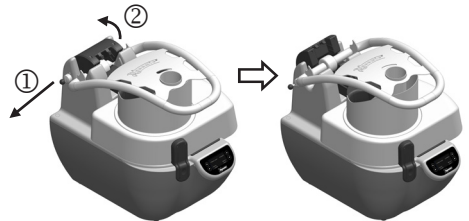

2. Pull the pusher handle vertically to release it.

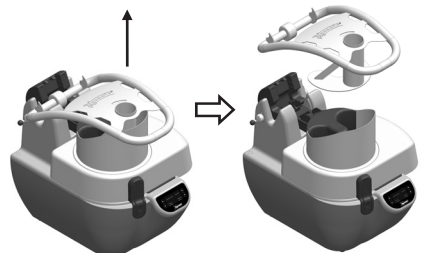

OPERATION OF THE VEGETABLE SLICER

3. Pull the latch ① to release the lid and pull it ②.

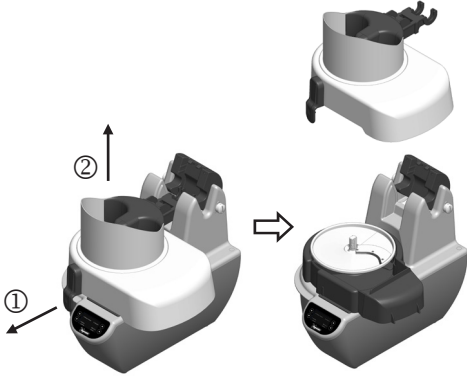

CHANGING AN ACCESSORY

1. Raise the handle to its stop and lift the lid to the clip to access the cutting area.

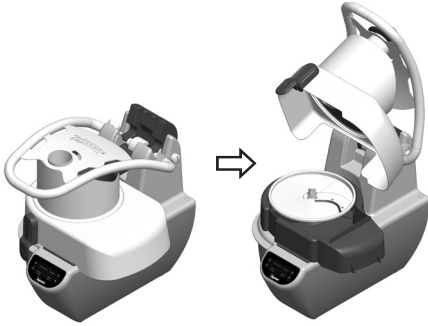

2. Remove the slicing or julienne disc by turning it in the direction of the arrow on the disc ① and pulling it ②.

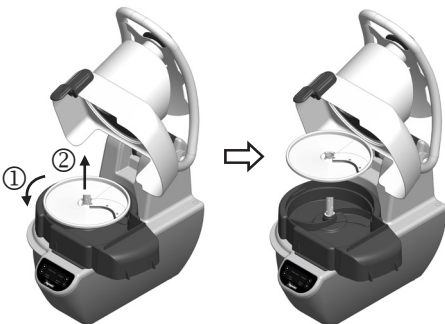

The discs have sharp edges. Be careful when handling, there is a risk of cuts.

3. Remove the dicing or French fries kit by first removing the slicing disc ① and then the grid ②.

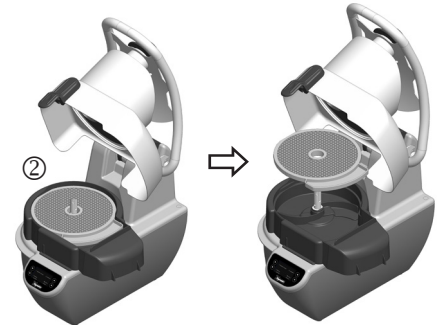
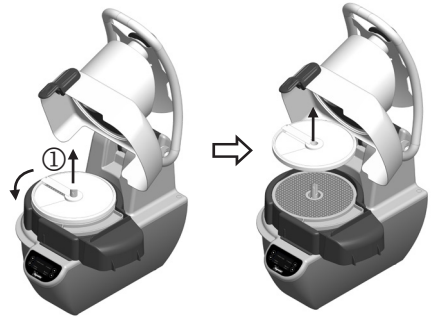

The discs have sharp edges. Be careful when handling, there is a risk of cuts.

4. To fit a new accessory, proceed with the previous steps but in reverse order.

OPERATION OF THE VEGETABLE SLICER

Choice of running mode

1. Plug in the unit.
2. Fit all the accessories (pusher handle, cover, etc...). See "Fitting accessories" section.



The discs and grids have sharp edges. Be careful when handling, there is a risk of cuts.

The Home screen is displayed.

SINGLE SPEED **2 SPEEDS**
ADJUSTABLE SPEED

Warning messages may appear when the lid or handle are not properly positioned.

Follow the instructions on the screen.

3. Load the food through the cylindrical chute (Fig. n°1) or through the kidney-shaped lid hopper. (Fig. n°2).

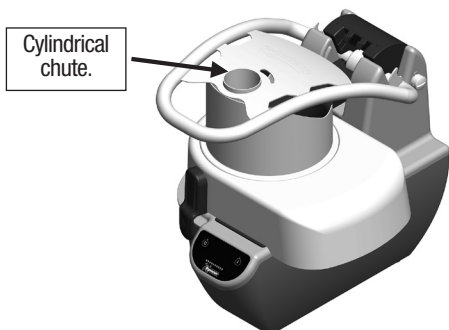

Fig. 1 / Loading through the cylindrical chute.

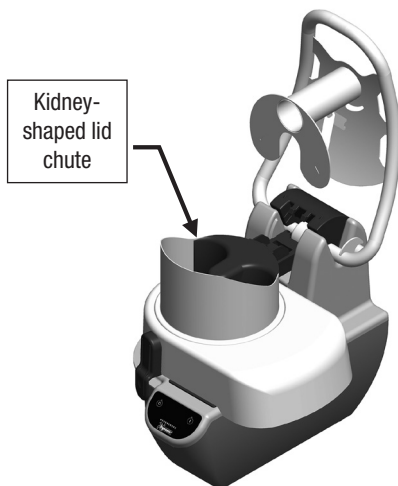

Fig. 2 / Loading through the kidney-shaped lid chute.

If the lid is not properly positioned, especially at the latch, and the handle is not lowered sufficiently, an alert message appears on the screen.

If necessary, reduce the amount of food in the kidney-shaped chute so that the handle can be detected.

1 speed operation mode

1. Press the "SINGLE SPEED" button to select the 1-speed mode.
2. Press the "ON" button to turn the appliance on.



SINGLE SPEED **2 SPEEDS**
ADJUSTABLE SPEED



ON **PULSE**
SINGLE SPEED
320 TR/MN
RETURN

OPERATION OF THE VEGETABLE SLICER



ON PULSE
SINGLE SPEED
320 TR/MN
RETURN

STOP
MACHINE RUNNING
SPEED
320 TR/MN

In this running mode, the speed is pre-programmed and cannot be changed.

To use the appliance at another motor speed, refer to "Operation in variable speed mode".

3. When loading food through the circular handle chute, use the pusher to move it down to the cutting area.



Do not force when pushing food in.

Do not push food with the hands or any other object. There is a risk of injury and damage to the appliance.

Only use the pusher to push food.

As the appliance is silent when there is no food, be careful when adding new food. There is a risk of food spraying.

4. When the kidney-shaped chute needs to be refilled, the handle must be raised. From a certain angle, this causes the appliance to stop and an alert message appears on the screen.

The appliance restarts automatically when the handle is sufficiently lowered.

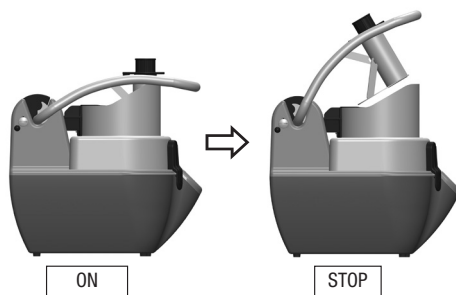

If the handle is not lowered sufficiently, an alert message appears on the screen. If necessary, reduce the amount of food in the kidney-shaped chute so that the handle can be detected.

5. Changing the disc (see "Changing the disc" section) requires lifting the lid and therefore causes the appliance to stop.

OPERATION OF THE VEGETABLE SLICER



Once the cover and handle have been lowered, it can only be restarted by pressing the "ON" button again.

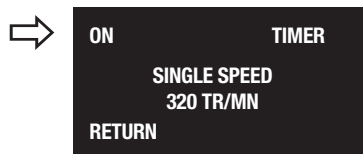

6. The appliance is switched off by pressing the "STOP" button.



2-speed operation mode

1. Press the "2 SPEEDS" button to select the 2-speed mode.

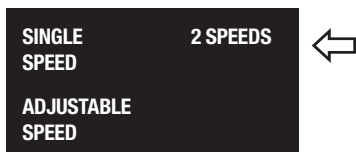

2. Select the speed by pressing one of the "SPEED 1" or "SPEED 2" buttons.

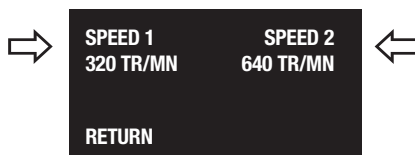

In this running mode, both speeds are pre-programmed.

To operate the appliance at other motor speeds, refer to "Using in variable speed mode".

3. Press the "ON" button to turn the appliance on.

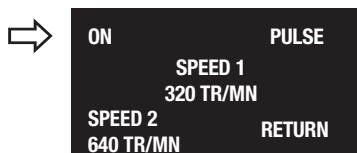

4. Load the food through the cylindrical chute or through the kidney-shaped lid chute.

If the lid is not properly positioned, especially at the latch, and the handle is not lowered sufficiently, an alert message appears on the screen.

If necessary, reduce the amount of food in the kidney-shaped chute so that the handle can be detected.

OPERATION OF THE VEGETABLE SLICER

5. To select speed 2, press the "SPEED 2" button.
To return to speed 1, press the "SPEED 1" button.

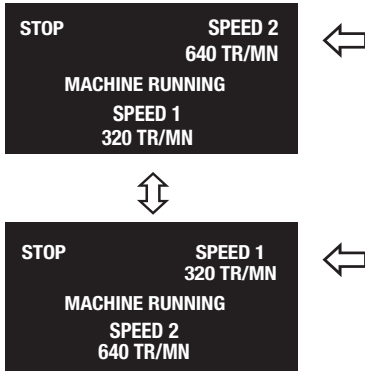

6. When loading food through the circular handle chute, use the pusher to move it down to the cutting area.



Do not force when pushing food in.

Only use the pusher to push food.

Do not push food with the hands or any other object. There is a risk of injury and damage to the appliance.

As the appliance is silent when there is no food, be careful when adding new food. There is a risk of food spraying.

7. When the kidney-shaped chute needs to be refilled, the handle must be raised. From a certain angle, this causes the appliance to stop and an alert message appears on the screen.

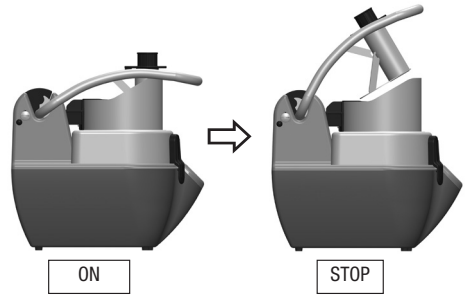

When the handle is raised, it is possible to switch from speed 1 to speed 2 by pressing button "2", and vice versa.

The appliance is restarted by pressing the "ON" button.

8. Changing the disc (see "Changing the disc" section) requires lifting the lid and therefore causes the appliance to stop.

Once the cover and handle have been lowered, it can only be restarted by pressing the "ON" button again.



9. The appliance is switched off by pressing the "STOP" button.



OPERATION OF THE VEGETABLE SLICER

Variable speed operation

1. Press the "ADJUSTABLE SPEED" button to select the variable-speed mode.

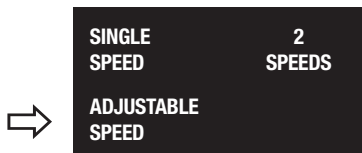

2. For continuous use, press the "ON" button.

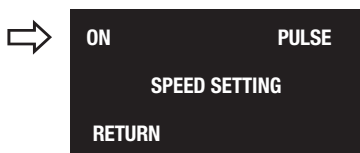

3. It is possible to adjust the speed by pressing the "-" and "+" buttons to reach the required value (from 320 to 720 rpm).

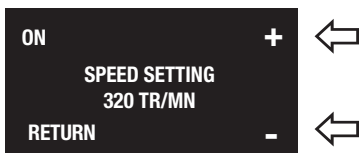

On powering-up, by default the speed is set to its minimum value (320 rpm).

4. Press the "ON" button to turn the appliance on.

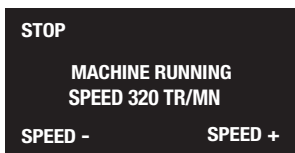
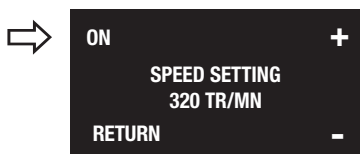

It is possible to adjust the speed at all times by the "SPEED -" and "SPEED +" buttons until the required value is reached.

5. Load the food through the cylindrical chute or through the kidney-shaped lid chute.

If the lid is not properly positioned, especially at the latch, and the handle is not lowered sufficiently, an alert message appears on the screen.

If necessary, reduce the amount of food in the kidney-shaped chute so that the handle can be detected.

6. When loading food through the circular handle chute, use the pusher to move it down to the cutting area.

Do not force when pushing food in.

Only use the pusher to push food.

Do not push food with the hands or any other object. There is a risk of injury and damage to the appliance.

As the appliance is silent when there is no food, be careful when adding new food. There is a risk of food spraying.



OPERATION OF THE VEGETABLE SLICER

7. When the kidney-shaped chute needs to be refilled, the handle must be raised. From a certain angle, this causes the appliance to stop.

It is possible to adjust the speed at all times by the "SPEED -" and "SPEED +" buttons until the required value is reached.

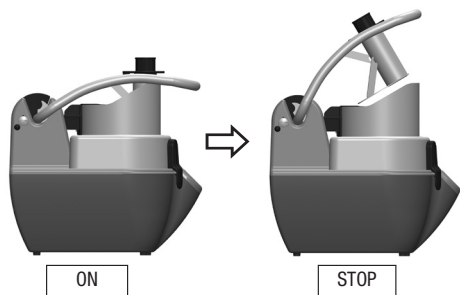

When the handle is raised, the motor rotation speed can be changed by pressing the "-" and "+" buttons.

The appliance is restarted by pressing the "ON" button.

8. Changing the disc (see "Changing the disc" section) requires lifting the lid and therefore causes the appliance to stop.

Once the cover and handle have been lowered, it can only be restarted by pressing the "ON" button again.



9. The appliance is switched off by pressing the "STOP" button.

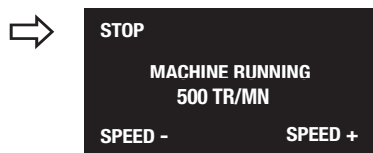

OPERATION OF THE FOOD PROCESSOR

Fitting of accessories

1. Fit the bowl on the motor block.

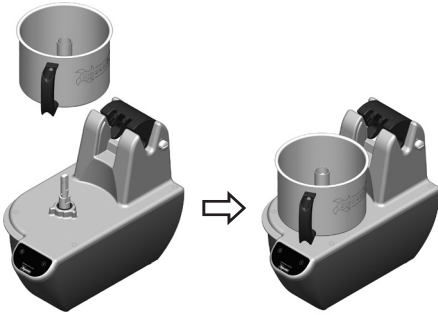

Be careful : the bowl needs to be properly positioned otherwise the device will not start.

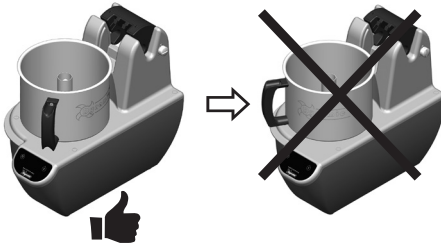

2. Check the general condition of the knife (sharpness, etc.) and fit it.

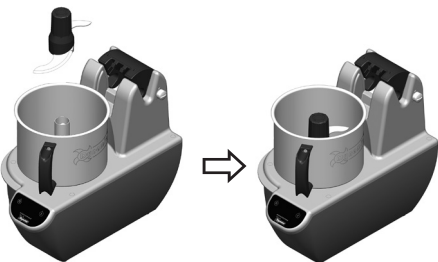

The knife has sharp edges. Be careful when handling, there is a risk of cuts.

3. Pull the lock latch and tilt the lock backwards.

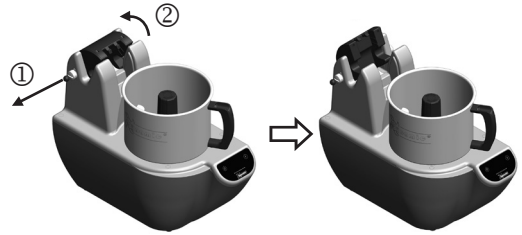

4. Fit the lid.

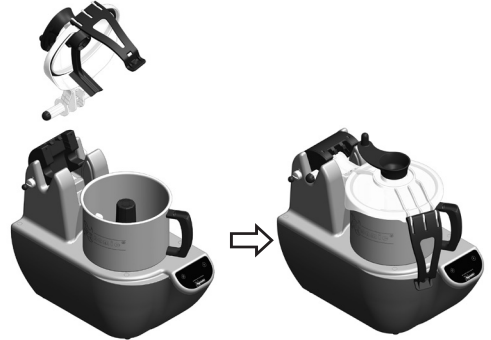

5. Tilt the lock ① and close the lid latch ②.

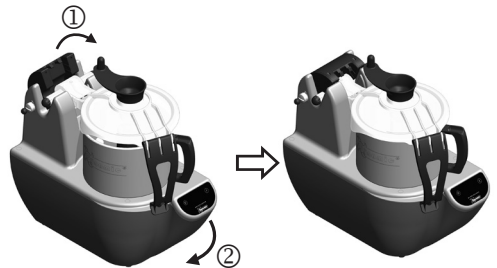

Removing the accessories

REMOVING THE LID

OPERATION OF THE FOOD PROCESSOR

1. Pull the lid latch **1** and then the pull tab **2** to release the latch and swing it back **3**.

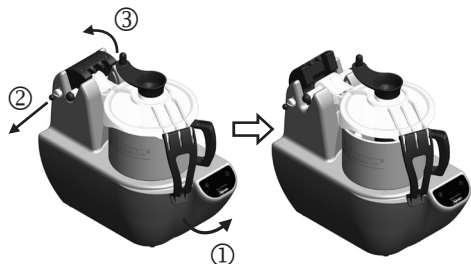

2. Pull the lid vertically to release it.

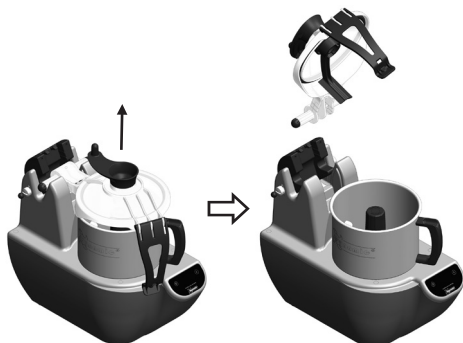

3. To refit the cover on the motor block, proceed in the reverse order of steps 1 and 2.

4. To remove the scraper, press the 2 parts together to release the scraper handle studs **1** and turn the handle **2**.

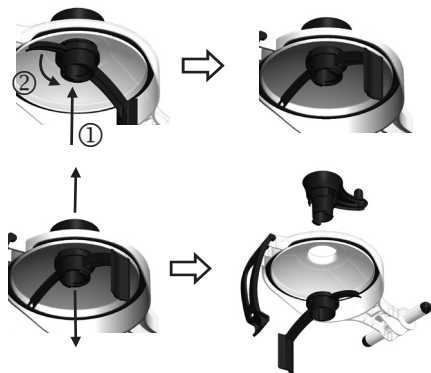

5. To refit the scraper, proceed in the reverse order from of step 4.

6. To remove the latch, turn it towards the underside of the cover **1** and move it vertically **2** and then horizontally **3** to release it.

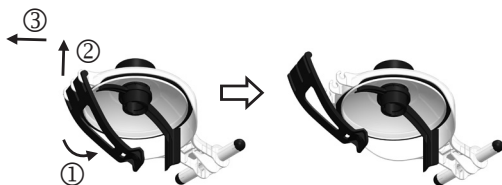

7. To refit the latch, proceed in the reverse order of step 6.

CHANGING A KNIFE

1. Pull the lid latch and lift the lid up to the clip to access the inside of the bowl.

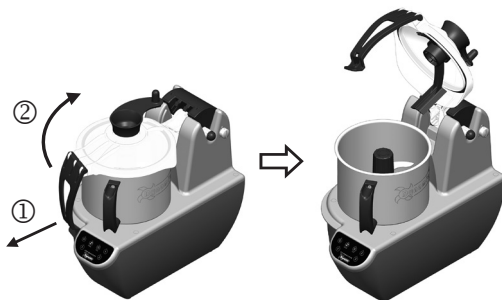

2. Pull the knife to remove it.

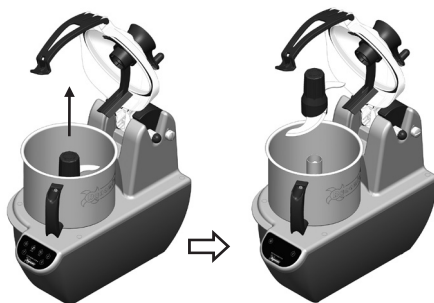

OPERATION OF THE FOOD PROCESSOR



The knife has sharp edges. Be careful when handling, there is a risk of cuts.

3. To fit a new knife, proceed with the previous steps but in reverse order.

Choice of running mode

1. Plug in the unit.
2. Fit all accessories (bowl, lid, etc...). See "Fitting accessories" section.



The knife has sharp edges.

Be careful when handling, there is a risk of cuts.

The Home screen is displayed.

SINGLE SPEED	2 SPEEDS
VARIABLE SPEED	REVERSE

Warning messages may appear when the lid or handle are not properly positioned.

Follow the instructions on the screen.

3. Load the food directly into the bowl or through the lid chute.



Fig. 1 / Loading food directly into the bowl.

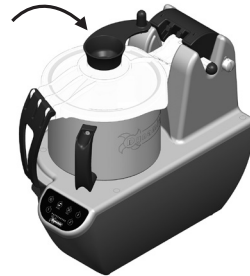

Fig. 2 / Loading food through the lid chute.

Be careful of the amount of food: too high quantities can cause overflow and spraying.

4. During use, food can be loaded through the lid chute.



OPERATION OF THE FOOD PROCESSOR

Do not force when pushing food in.

Do not push food with the hands or any other object. There is a risk of injury and damage to the appliance.

As the appliance is silent when there is no food, be careful when adding new food. There is a risk of food spraying.

Be careful of the amount of food: too high quantities can cause overflow and spraying.

5. During use, food can be removed from the bowl wall by rotating the scraper.



1-speed operation mode

The device must always be under the supervision of the user for the entire duration of its use.

Depending on the preparations, the appliance may be subject to vibrations that may cause it to move on its work surface.

1. Press the "1 SINGLE SPEED" button to select the 1-speed mode.



SINGLE SPEED	2 SPEEDS
ADJUSTABLE VARIABLE	REVERSE

ON	PULSE
SINGLE SPEED 1500 TR/MN	
RETURN	>

By pressing the ">" BUTTON, the timer (TIMER) and stopwatch modes can be accessed.

ON	PULSE
SINGLE SPEED 1500 TR/MN	
RETURN	>

0

ON	TIMER
SINGLE SPEED 1500 TR/MN	
RETURN	>

0

ON	CHRONO
SINGLE SPEED 1500 TR/MN	
RETURN	>

CONTINUOUS OPERATION

1. For continuous use, press the "ON" button.
The appliance starts.



ON	PULSE
MACHINE RUNNING 1500 TR/MN	
RETURN	>

STOP	
SPEED UNIQUE 1500 TR/MN	

OPERATION OF THE FOOD PROCESSOR

- When food refilling is required by unlocking the lid, this will stop the appliance.



Machine stop

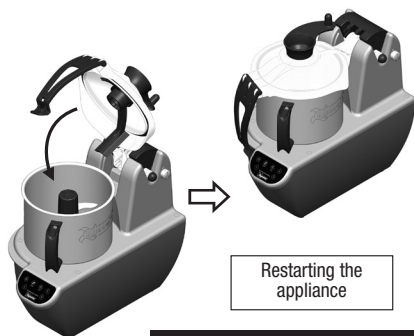

Restarting the appliance

ON PULSE
SINGLE SPEED
1500 TR/MN
RETURN >

Be careful of the amount of food: too high quantities can cause overflow and spraying.

Once the cover has been lowered, it can only be restarted by pressing the "ON" button again.

- The appliance is switched off by pressing the "STOP" button.



STOP
SINGLE SPEED
1500 TR/MN

PULSE OPERATION

- For pulse use, press the "PULSE" button.

ON PULSE ←
SINGLE SPEED
1500 TR/MN
RETURN >

MACHINE RUNNING
1500 TR/MN

- The appliance stops when the button is released.

USING THE TIMER (TIMER)

- For stopwatch use, press the "TIMER" button. The time setting screen is displayed.

ON TIMER ←
SINGLE SPEED
1500 TR/MN
RETURN >

OK +
TIME SETTING
RETURN 00mn00s -

- Adjust the speed by pressing the "-" and "+" buttons.

The time can be set up to a maximum value of 20 minutes.

OK + ←
TIME SETTING
RETURN 00mn00s - ←

OPERATION OF THE FOOD PROCESSOR

Pressing the "RETURN" button goes back to the previous screen.

- When the time is set to the required value, press the "OK" button to confirm.

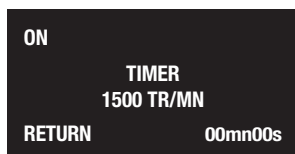
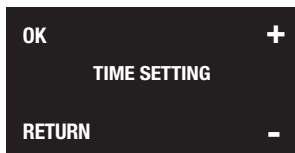

- Press the "ON" button to turn the appliance on.

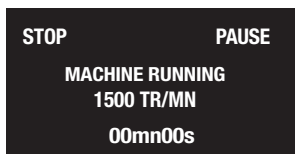
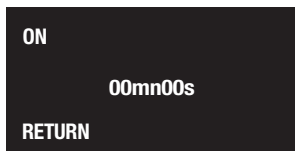

The appliance stops automatically when the timer reaches "00mn00s".

- Pressing the "PAUSE" button temporarily stops the appliance motor and saves the time value.

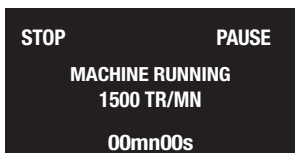

- It is then possible to change the operating time by pressing the "MODIF. TIME" button (see Step 3).

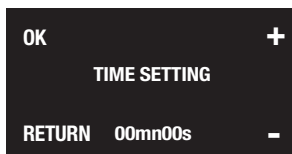
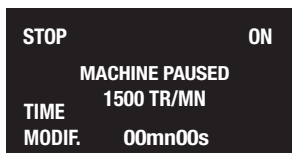
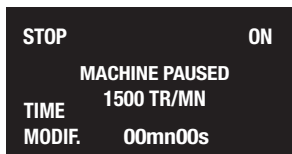

Press the "ON" button to operate the appliance again.

- Pressing the "STOP" button stops the motor and timer function.

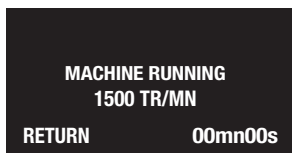

- Pressing the "RETURN" button returns to the main menu.

OPERATION OF THE FOOD PROCESSOR

USING THE STOPWATCH (CHRONO)

1. For stopwatch use, press the "CHRONO" button.

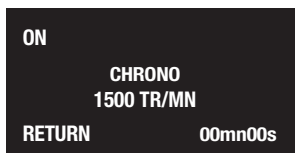
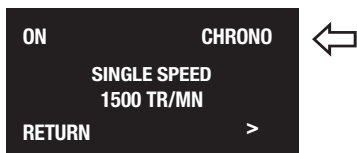

2. Press the "ON" button to turn the appliance on.

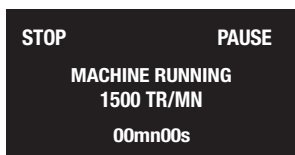
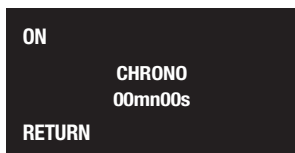

The appliance stops automatically after 20 minutes.

3. Press the "ON" button to operate the appliance again.

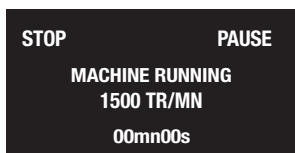
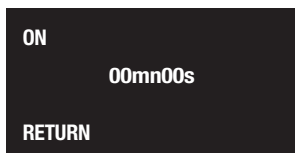

4. Pressing the "PAUSE" button temporarily stops the appliance motor.

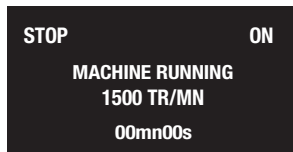
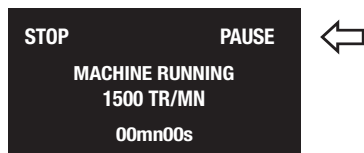

5. Pressing the "ON" button restarts the appliance.

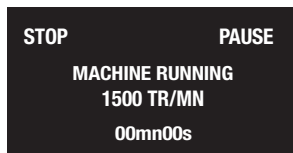
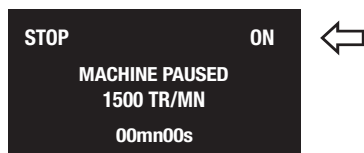

6. Pressing the "STOP" button stops the motor and stopwatch function.

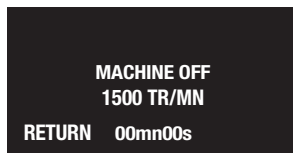
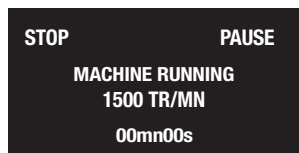

7. Pressing the "RETURN" button returns to the main menu.

OPERATION OF THE FOOD PROCESSOR

2-speed operation mode

The device must always be under the supervision of the user for the entire duration of its use.

Depending on the preparations, the appliance may be subject to vibrations that may cause it to move on its work surface.

1. Fit all accessories (bowl, lid, etc...). See "Fitting accessories" section.
2. Press the "2 SPEEDS" button to select the 2-speed mode.

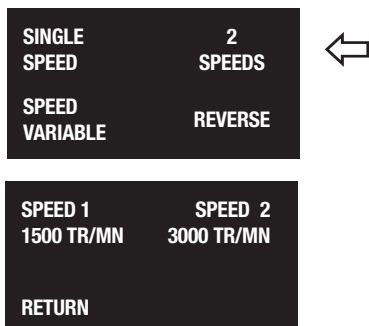

In this running mode, both speeds are pre-programmed.

3. Press one of the "SPEED 1 1500 TR/MN" and "SPEED 2 3000 TR/MN" buttons to select the required speed.

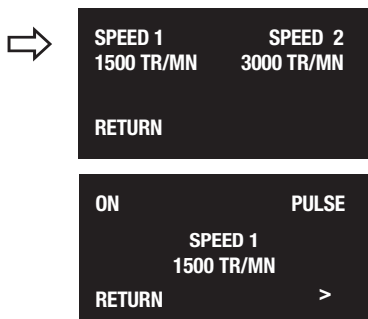

By pressing the ">" BUTTON, the timer (TIMER) and stopwatch modes can be accessed.

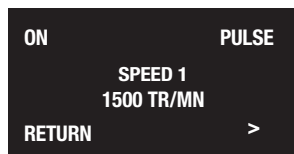

0

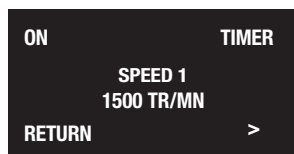

0

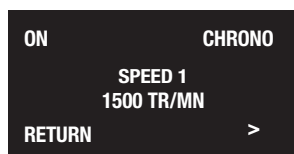

CONTINUOUS OPERATION

1. For continuous use, press the "ON" button.

The appliance starts.

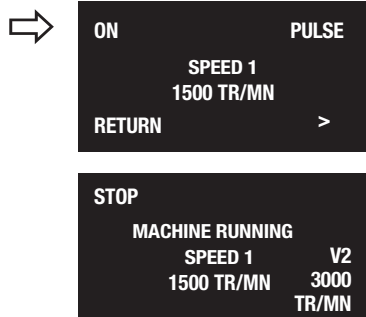

OPERATION OF THE FOOD PROCESSOR

It is possible to switch to speed 2 at all times by pressing the "V2 3000TR/MN" button.

- When food refilling is required by unlocking the lid, this will stop the appliance.



Machine stop

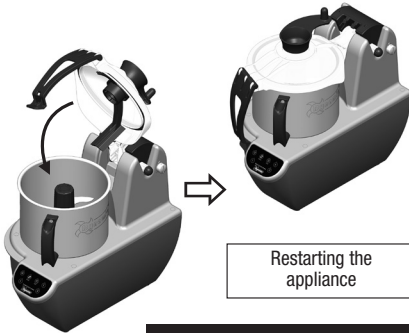

Restarting the appliance

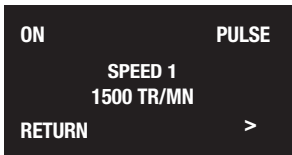

Be careful of the amount of food: too high quantities can cause overflow and spraying.

Once the cover has been lowered, it can only be restarted by pressing the "ON" button again.

- The appliance is switched off by pressing the "STOP" button.



PULSE OPERATION

- For stopwatch use, press the "ON" button. The appliance starts.

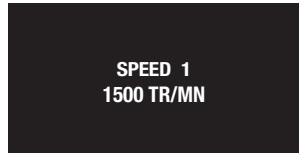
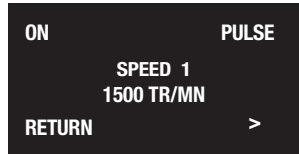

- The appliance stops when the button is released.

USING THE TIMER (TIMER)

- For stopwatch use, press the "CHRONO" button. The time setting screen is displayed.

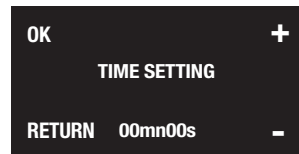
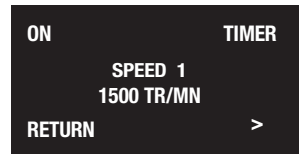

- Adjust the speed by pressing the "-" and "+" buttons. The time can be set up to a maximum value of 20 minutes.

OPERATION OF THE FOOD PROCESSOR

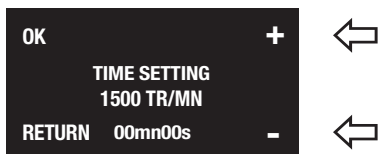

Pressing the "RETURN" button goes back to the previous screen.

- When the time is set to the required value, press the "OK" button to confirm.

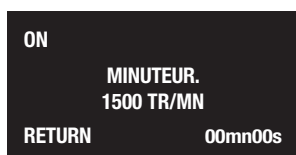
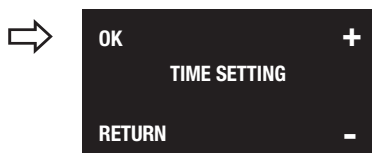

It is possible to switch to speed 2 by pressing the "V2 3000TR/MN" button.

- Press the "ON" button to turn the appliance on.

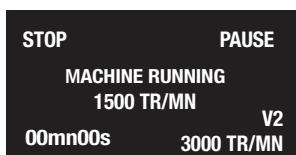
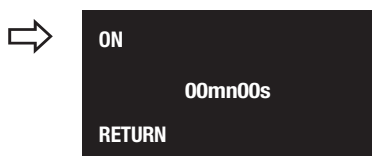

It is possible to switch to speed 2 by pressing the "V2 3000TR/MN" button.

- Pressing the "PAUSE" button temporarily stops the appliance motor.

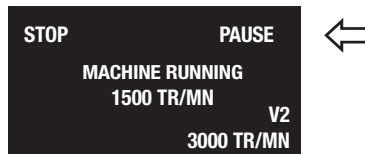

It is possible to switch to speed 2 by pressing the "V2 3000TR/MN" button.

- It is then possible to change the operating time by pressing the "MODIF. TIME" button (see Step 3).

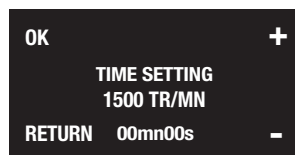

Adjust the speed by pressing the "-" and "+" buttons.

The time can be set up to a maximum value of 20 minutes.

Press the "OK" button to operate the appliance again.

- Pressing the "STOP" button stops the motor and timer function.

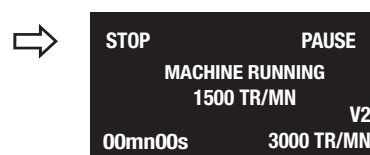

OPERATION OF THE FOOD PROCESSOR



8. Pressing the "RETURN" button returns to the main menu.

USING THE STOPWATCH (CHRONO)

1. For stopwatch use, press the "CHRONO" button.

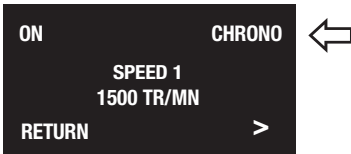

2. Press the "ON" button to turn the appliance on.

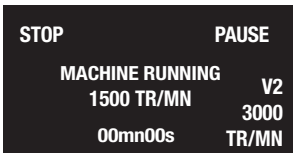
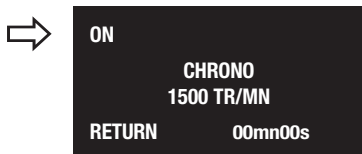

The appliance stops automatically after 20 minutes.

3. Pressing the "PAUSE" button temporarily stops the appliance motor.

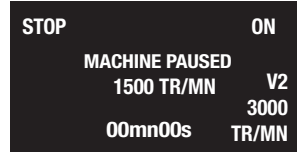

It is possible to switch to speed 2 by pressing the "V2 3000TR/MN" button.

4. Press the "ON" button to operate the appliance again.

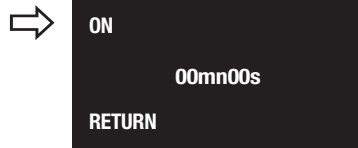

5. Pressing the "STOP" button stops the motor and stopwatch function.

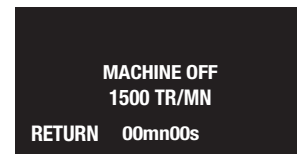

6. Pressing the "RETURN" button returns to the main menu.

OPERATION OF THE FOOD PROCESSOR

Variable speed operation

The device must always be under the supervision of the user for the entire duration of its use.

Depending on the preparations, the appliance may be subject to vibrations that may cause it to move on its work surface.

1. Fit all accessories (bowl, lid, etc...). See "Fitting accessories" section.
2. Press the "VARIABLE SPEED" button to select the variable-speed mode.

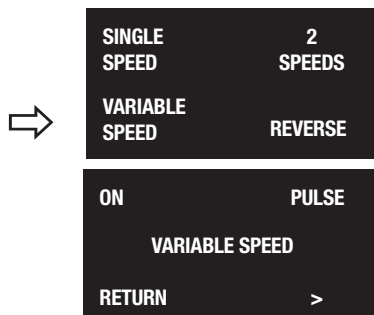

By pressing the ">" BUTTON, the timer (TIMER) and stopwatch modes can be accessed.

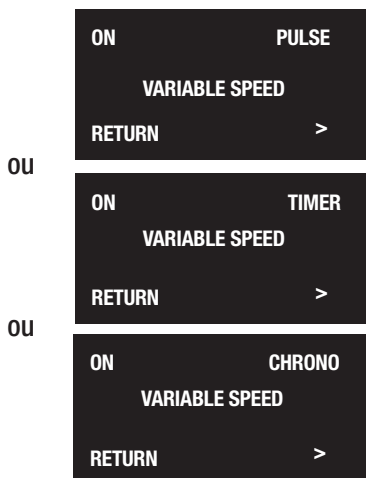

CONTINUOUS OPERATION

1. For continuous use, press the "ON" button. The speed setting screen will then be displayed.

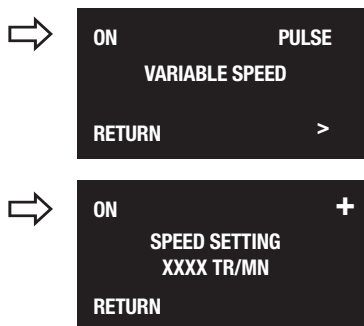

It is then possible to adjust the speed by pressing the "-" and "+" buttons to reach the required value (from 350 to 3500 rpm).

2. Press the "ON" button to turn the appliance on.

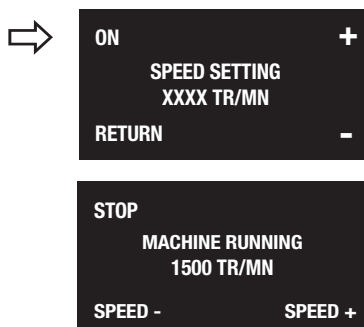

During use, it is then possible to adjust the speed by pressing the "SPEED -" and "SPEED +" buttons until the required value is reached.

3. When food refilling is required by unlocking the lid, this will stop the appliance.

OPERATION OF THE FOOD PROCESSOR



Machine stop

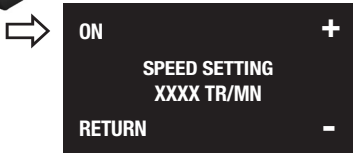
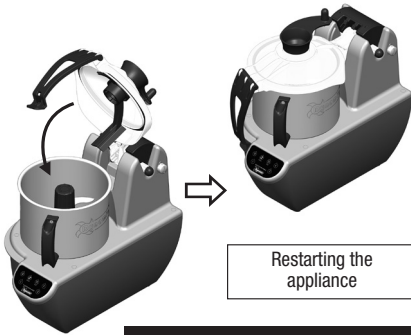

Be careful of the amount of food: too high quantities can cause overflow and spraying.

Once the cover has been lowered, it can only be restarted by pressing the "ON" button again.

4. The appliance is switched off by pressing the "STOP" button.

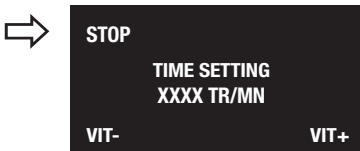

PULSE OPERATION

1. For stopwatch use, press the "ON" button. The speed setting screen will then be displayed.

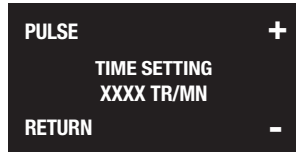
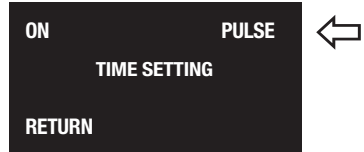

It is then possible to adjust the speed by pressing the "-" and "+" buttons to reach the required value (from 350 to 3500 rpm).

2. Press the "PULSE" button to turn the appliance on.

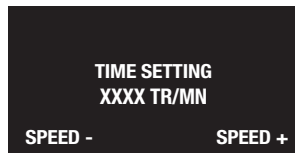
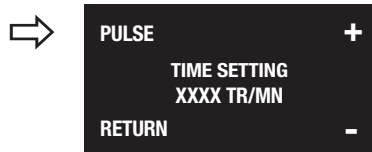

It is possible to adjust the speed at all times by the "SPEED -" and "SPEED +" buttons until the required value is reached.

3. The appliance stops when the button is released.

USING THE TIMER (TIMER)

1. For stopwatch use, press the "TIMER" button. The time setting screen is displayed.

OPERATION OF THE FOOD PROCESSOR

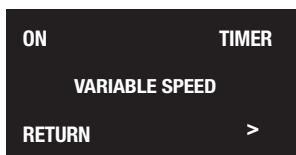

4. Press the "ON" button to turn the appliance on.

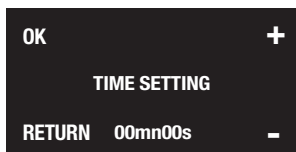
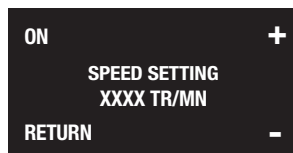

2. Adjust the speed by pressing the "-" and "+" buttons.

The time can be set up to a maximum value of 20 minutes.

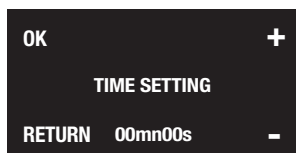

It is possible to adjust the speed at all times by the "SPEED -" and "SPEED +" buttons until the required value is reached.

5. Pressing the "PAUSE" button temporarily stops the appliance motor.

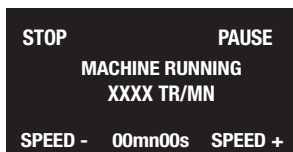

Pressing the "RETURN" button goes back to the previous screen.

3. When the time is set to the required value, press the "OK" button to confirm and move on to the speed setting.

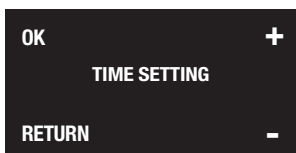

6. It is then possible to change the operating time by pressing the "MODIF. TIME" button (see Step 3).

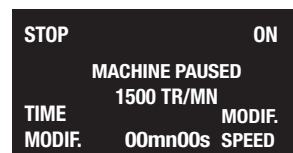
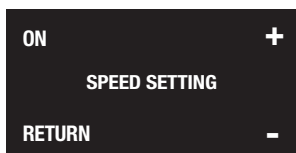

It is then possible to adjust the speed by pressing the "-" and "+" buttons to reach the required value (from 350 to 3500 rpm).

OPERATION OF THE FOOD PROCESSOR

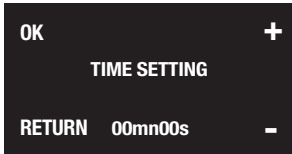

Press the "-" and "+" buttons to change the operating time.

7. Pressing the "OK" accesses the speed setting (see § 7).

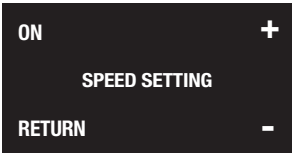
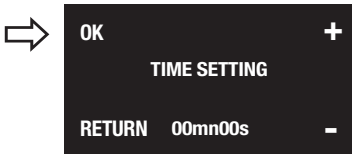

8. It is possible to adjust the speed by the "SPEED MODIF." button.

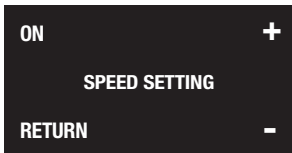
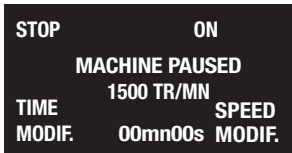

9. Press the "ON" button to operate the appliance again.

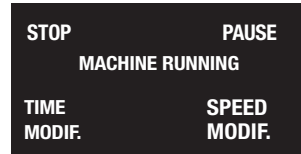
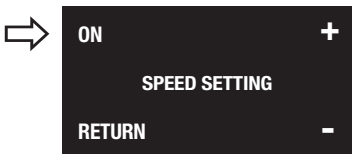

10. Pressing the "STOP" button stops the motor and timer function.

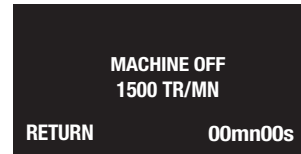
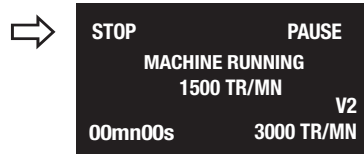

11. Pressing the "RETURN" button returns to the main menu.

USING THE STOPWATCH (CHRONO)

1. For stopwatch use, press the "CHRONO" button.

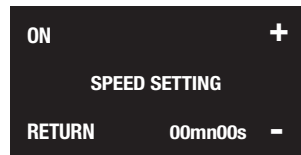
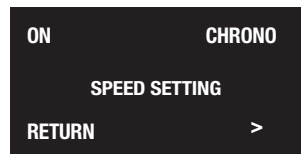

2. Press the "ON" button to turn the appliance on.

OPERATION OF THE FOOD PROCESSOR

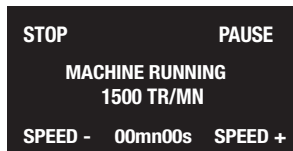
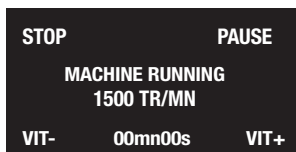
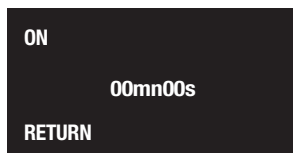
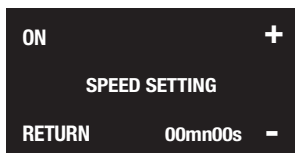

The appliance stops automatically after 20 minutes.

3. Pressing the "PAUSE" button temporarily stops the appliance motor.

It is possible to adjust the speed at all times by the "SPEED -" and "SPEED +" buttons until the required value is reached.

5. Pressing the "STOP" button stops the motor and stopwatch function.

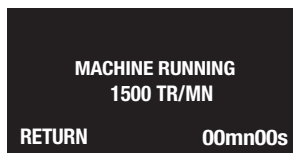
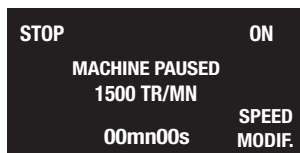
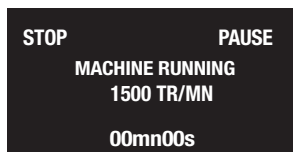
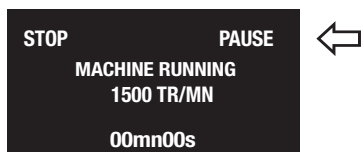

It is possible to switch to speed 2 by pressing the "V2 3000TR/MN" button.

4. Press the "ON" button to operate the appliance again.

6. Pressing the "RETURN" button returns to the main menu.

OPERATION OF THE FOOD PROCESSOR

Starting in "REVERSE" mode

The device must always be under the supervision of the user for the entire duration of its use.

Depending on the preparations, the appliance may be subject to vibrations that may cause it to move on its work surface.

1. Fit all accessories (bowl, lid, etc...). See "Fitting accessories" section.
2. Press the "REVERSE" button to select reverse mode.

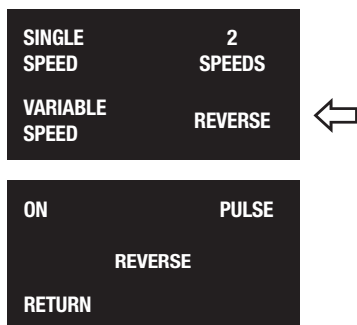

CONTINUOUS OPERATION

1. For continuous use, press the "ON" button. The speed setting screen will then be displayed.

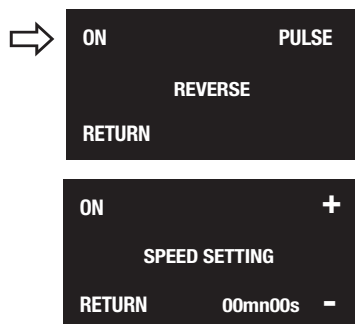

It is then possible to adjust the speed by pressing the "-" and "+" buttons to reach the required value (from 50 to 350 rpm).

2. Press the "ON" button to turn the appliance on.

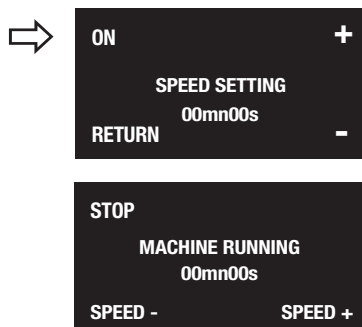

It is possible to adjust the speed at all times by the "SPEED -" and "SPEED +" buttons until the required value is reached.

3. During use, food can be loaded through the lid chute.



Do not force when pushing food in.

Do not push food with the hands or any other object. There is a risk of injury and damage to the appliance.

As the appliance is silent when there is no food, be careful when adding new food. There is a risk of food spraying.

Be careful of the amount of food: too high quantities can cause overflow and spraying.

OPERATION OF THE FOOD PROCESSOR

4. During use, food can be removed from the bowl wall by rotating the scraper.



5. When food refilling is required by unlocking the lid, this will stop the appliance.



Machine stop



Restarting the appliance

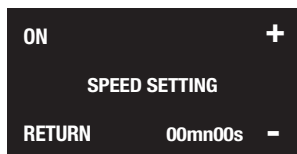

Be careful of the amount of food: too high quantities can cause overflow and spraying.

Once the cover has been lowered, it can only be restarted by pressing the "ON" button again.

6. The appliance is switched off by pressing the "STOP" button.

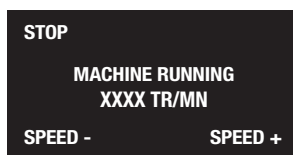

PULSE OPERATION

1. For pulse use, press the "ON" button. The speed setting screen will then be displayed.

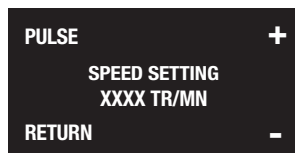

It is then possible to adjust the speed by pressing the "-" and "+" buttons to reach the required value.

2. Press the "PULSE" button to turn the appliance on.

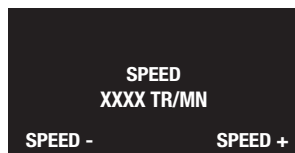
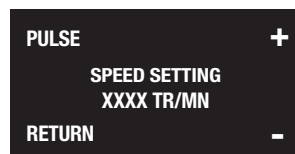

During use, it is then possible to adjust the speed by pressing the "SPEED -" and "SPEED +" buttons until the required value is reached.

3. The appliance stops when the button is released.

CLEANING

ACCESSORY CLEANING

1. Unplug the appliance.
2. Remove all accessories (see corresponding sections).
3. Rinse the accessories using a hand spray (do not use aggressive cleaning products) or in the dishwasher using non-aggressive detergents.
4. Store accessories in a dry and ventilated place.



Accessories can have sharp edges. Be careful when handling, there is a risk of cuts.

MOTOR-BLOCK CLEANING

1. Unplug the appliance.
2. Remove all accessories (see corresponding sections).
3. Clean the motor block using a sponge or a clean, slightly damp cloth.
4. The lock can be removed by unlocking the shafts using a flat-tipped screwdriver.

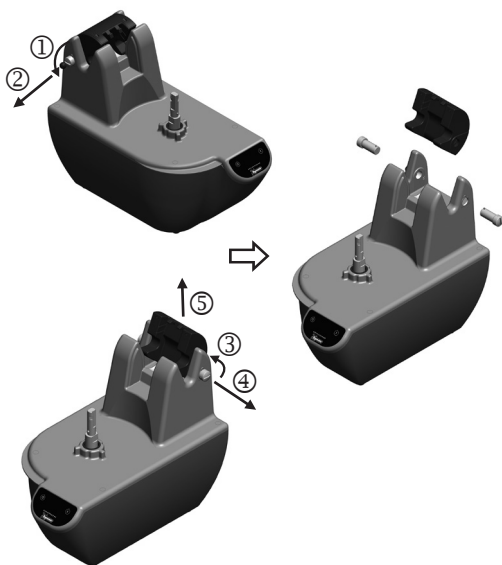
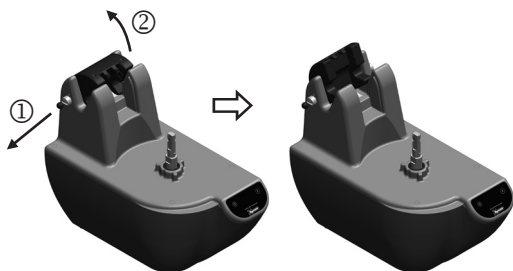

Do not clean the motor block with a water hose. Never immerse the motor block in water

MAINTENANCE

AFTER EVERY USE

Check the general condition of the supply cord (cutting, crushing, etc.).

Remove accessories after each use.

Clean accessories. Check for food residue before storing in a dry, ventilated area.

Check the general condition of the accessories before storing them (sharpness of the blades, warping, etc.).

Check the seal condition.

EVERY YEAR

Check the appliance stability. If necessary, replace damaged pads.

Replace the waterproof seal.

The discs and grids are wearing parts which

must be replaced regularly to guarantee a good quality of cut.

ELECTRIC REQUIREMENTS

The appliance is powered by a single phase alternating current and requires a "u" ground plug.

The installation must be protected by a ground fault circuit breaker and a 16 A calibre fuse.

Use a standardised 10/16 A single phased socket.

ELECTRICAL DIAGRAM

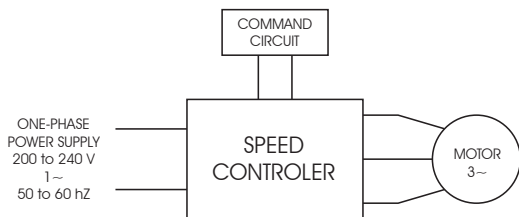

"CERTIFICATE OF CONFORMITY CUSTOMER SERVICE AND WARRANTY"

This machine is in accordance with BSI EN 1678 standard and the Supply of Machinery (Safety) Regulations 2008.

CUSTOMER SERVICE AND WARRANTY:

Should your unit require service, contact your distributor for the nearest authorized service centre if you wish your unit to be serviced by the manufacture ship it to :

DYNAMIC FRANCE S.A.S.

518 rue Léo Baekeland – B.P.57

85290 Mortagne-sur-Sèvre Cedex - FRANCE

Tel. +33 (0)2 51 63 02 72

Fax : +33 (0)2 51 63 02 73

e-mail : export@dynamicmixers.com

DYNAMIC warrants products to be free of manufacturing defects for a period of one year from the day of original shipment, covering all parts and labor.

DYNAMIC warranty covers parts and labour.

Damage caused by improper use, accident and/ or abuse are not considered to be manufacturing defects. Unauthorized work on the products during the warranty period will void this warranty. The portion below must be sent to the Service Centre within 10 days from the purchase date.

To be valid, the warranty certificate must be :

1. Certified by the seller (date and stamp).
2. Sent with the device in case of repair under warranty.

WARRANTY:

If your machine does not work normally, please ask advice to your distributor who can often help you, or send the machine, well packed, to:

DYNAMIC FRANCE S.A.S.

518 rue Léo Baekeland – B.P.57
85290 Mortagne-sur-Sèvre – France

DYNAMIC will repair or replace, at its discretion, defective products returned to an authorized warranty repair center, freight prepaid one way.

SCHEMATIC AND PART LIST

CL150 - ELECTRICAL VEGETABLE SLICER WITH DIGITAL DISPLAY SCREEN

CODE	PARTS LIST
3826	VEGETABLE PUSHER
3827	COMPLETE HANDLE
3828	COMPLETE COVER
3844	8MM DICING DISC
384401	10MM DICING DISC
3845	8MM DICING GRID
3846	8MM FRENCH FRIES GRID
3847	EJECTOR
3848	EVACUATION TUB
3854	MOTOR-BLOCK WITH SCREEN 220-240V
CL1005	SLICING DISC 0.5 MM
CL1015	SLICING DISC 1.5 MM
CL1025	SLICING DISC 2.5 MM
CL1030	SLICING DISC 3 MM
CL1040	SLICING DISC 4 MM
CL1050	SLICING DISC 5 MM
CL1070	SLICING DISC 7 MM
CL1080	SLICING DISC 8 MM
CL1090	SLICING DISC 9 MM
CL1110	SLICING DISC 11 MM
CL1120	SLICING DISC 12 MM
CL1130	SLICING DISC 13 MM
CL2002	GRATING DISC 2 MM
CL2003	GRATING DISC 3 MM
CL2005	GRATING DISC 5 MM
CL2009	GRATING DISC 9 MM
CL3032	JULIENNE DISC 3 X 2 MM
CL3042	JULIENNE DISC 4 X 2 MM
CL3044	JULIENNE DISC 4 X 4 MM
CL3052	JULIENNE DISC 5 X 2 MM
CL3055	JULIENNE DISC 5 X 5 MM
CL3088	JULIENNE DISC 8 X 8 MM
CL4008	DICING KIT 8 X 8 MM
CL5008	FRENCH FRIES KIT 8 X 8 MM
CL9000	COMPLETE VEGETABLE SLICER KIT (COVER, PUSHER HANDLE, TRAY)
CL9001	COMPLETE FOOD PROCESSOR KIT (BOWL, LID, SMOOTH BLADE)

CL9000

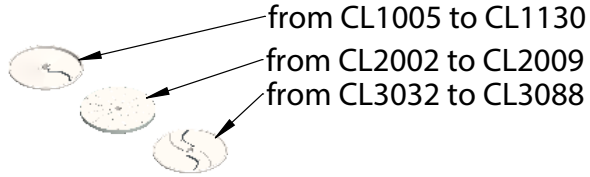
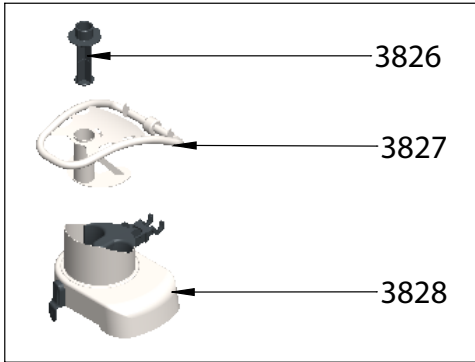

CL4008-CL5008

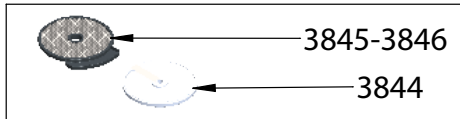

CL9000

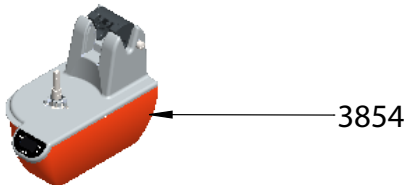
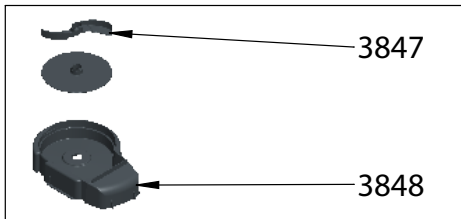

SCHEMATIC AND PART LIST

CL250 - FOOD PROCESSOR WITH DIGITAL DISPLAY SCREEN

CODE	PARTS LIST
3849	COMPLETE CUTTER COVER
3850	CUTTER BOWL
3854	MOTOR-BLOCK WITH SCREEN 220-240V
CL8001	SMOOTH EDGED BLADE FOOD PROCESSOR
CL9001	COMPLETE FOOD PROCESSOR KIT (BOWL, LID, SMOOTH BLADE)

CL9001

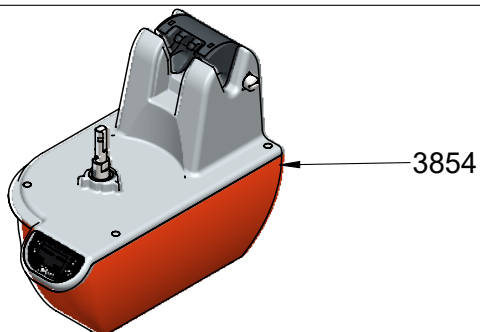
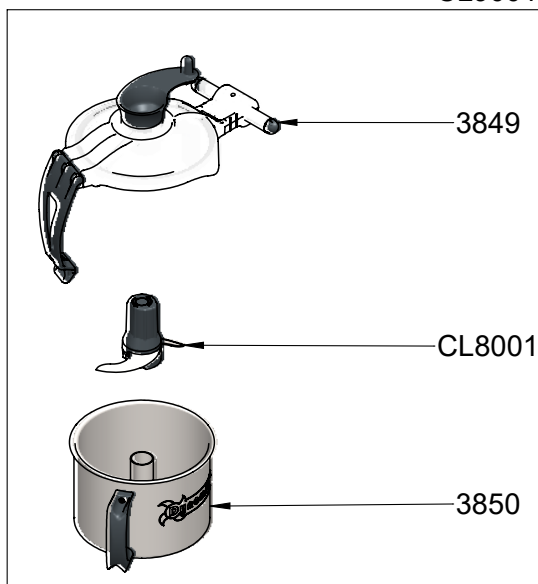

SCHEMATIC AND PART LIST

3828 - VEGETABLE SLICER COVER

CODE	PART LIST
382801	KIT FOR COVER CLIP
382802	COVER LATCH KIT
3842	STAINLESS STEEL COVER ASSEMBLY

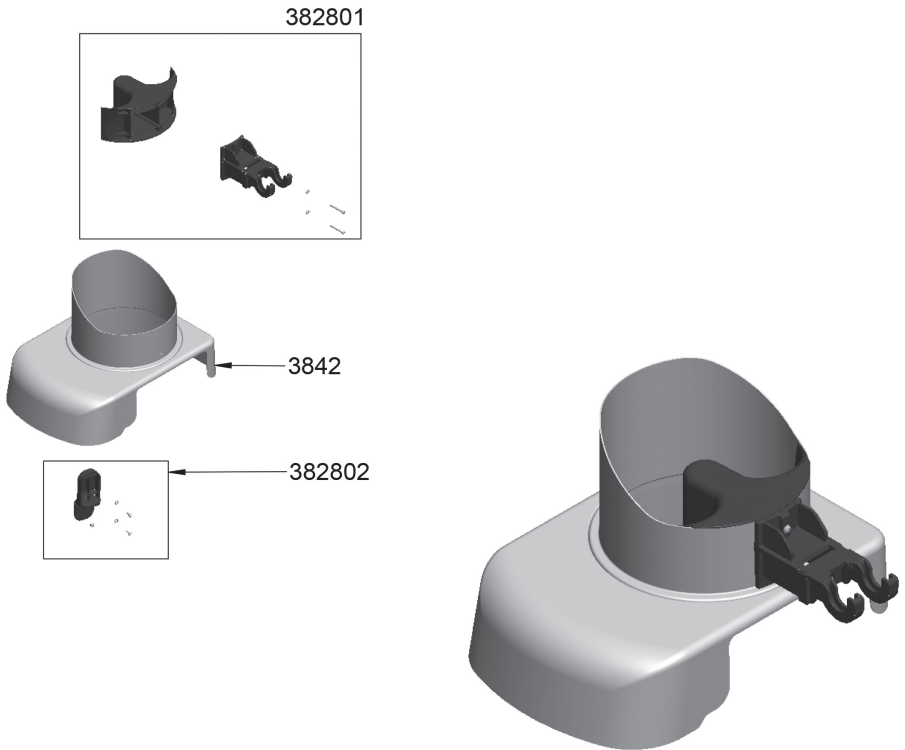

SCHEMATIC AND PART LIST

3849 - FOOD PROCESSOR COVER

CODE	PART LIST
0668	COVER SEAL
3834	HOPPER
3835	SCRAPER
384901	LATCH
384902	COVER
384903	SCRAPER AND HOPPER

384903

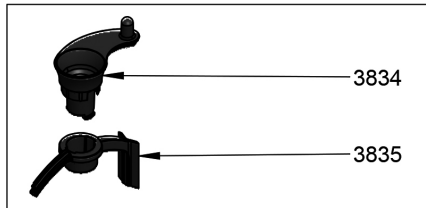

384902

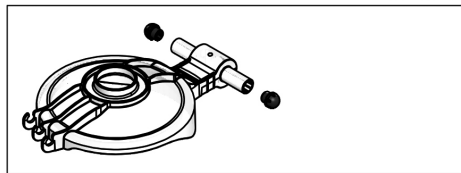

0668

384901

SCHEMATIC AND PART LIST

3850 - STAINLESS STEEL BOWL

CODE	PART LIST
3832	STAINLESS STEEL BOWL ASSEMBLY
385001	CUTTER BOWL HANDLE KIT
385002	CUTTER BOWL FITTING KIT

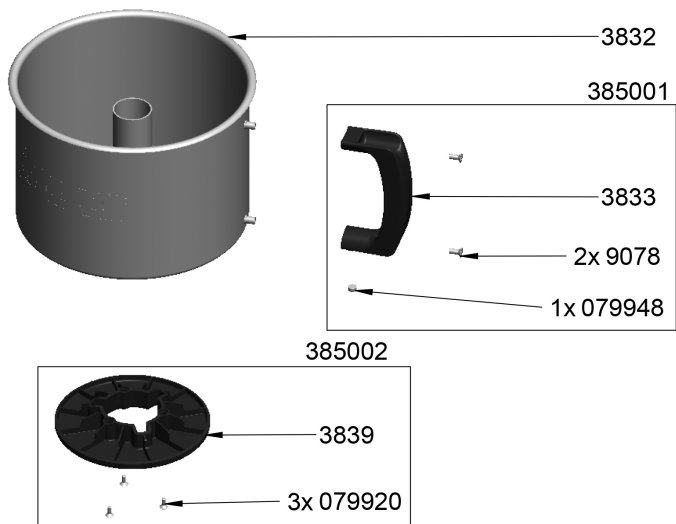

SCHEMATIC AND PART LIST

3854 - MOTOR-BLOCK WITH DIGITAL DISPLAY SCREEN

CODE	PARTS LIST
0600CL	WATERPROOF SEAL
0796	M6x20 SCREW
079985	M6x30 SCREW
119965G	GREY CAP
3820	EU PLUG POWER CORD (220-240V)
3820UK	UK PLUG POWER CORD (220-240V)
3821	240V ONE-PHASED VARIABLE SPEED DRIVER 1.5 Kw
3823	CABLE CLIP
3824	STRAIN RELIEF
3825	PAD
385101	ORANGE TANK WITH PADS
385102	SPEED CONTROLLER, HOLDER AND SCREWS
385103	MOTOR, FAN AND SCREWS
385104	SENSOR SET FOR HANDLE
385105	SENSOR SET
385106	LOCKING SYSTEM
385107	SCREWS SET FOR MOTOR-BLOCK
385108	LOCKING SYSTEM BEARING WITH PIN
385109	LOCKING AXIS SET
385410	KIT FOR SCREEN COMMAND BOARD

SCHEMATIC AND PART LIST



385106

385107

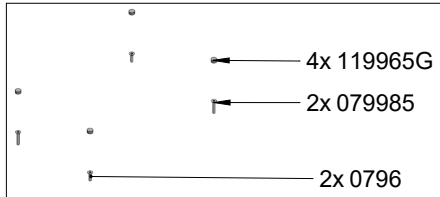

4x 119965G

2x 079985

2x 0796

385109

0600CL

385410

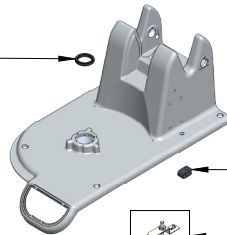

3823

385104

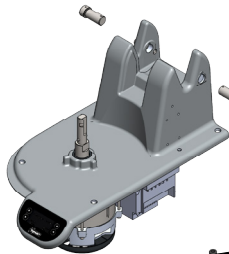

2x 385108

3824

385101



385105

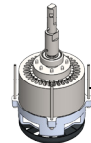

385103

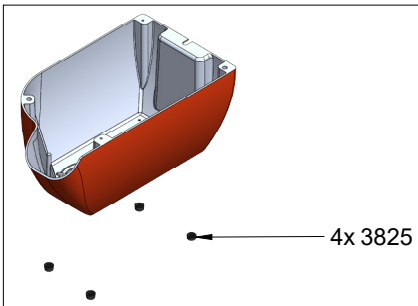

4x 3825

385102

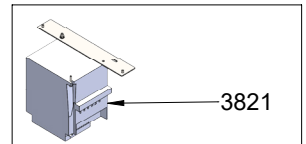

3821

WARRANTY

- Hotel, Inn
 - Restaurant
 - Cafeteria
 - Bakery, Patisserie
 - Ice-cream manufacturer
 - Hospital
 - Other
-

• Name

.....

• Address

.....

• City

.....

• Zip code

.....

• Telephone

.....

DYNAMIC FRANCE S.A.S.

S.A.S. au capital de 216.780 Euros - RCS 416 450 435 - La Roche-sur-Yon

518 rue Léo Baekeland – B.P.57

85290 Mortagne-sur-Sèvre Cedex - FRANCE

Tel. +33 (0)2 51 63 02 72

Fax : +33 (0)2 51 63 02 73

E-mail : export@dynamicmixers.com

www.dynamicmixers.com

Dealer's stamp

